

For Permit Only
05/13/2021 11:46:31 AM

NOTE: LOCATION OF UNDERGROUND UTILITIES IS APPROXIMATE. NOT ALL UTILITIES ARE SHOWN.

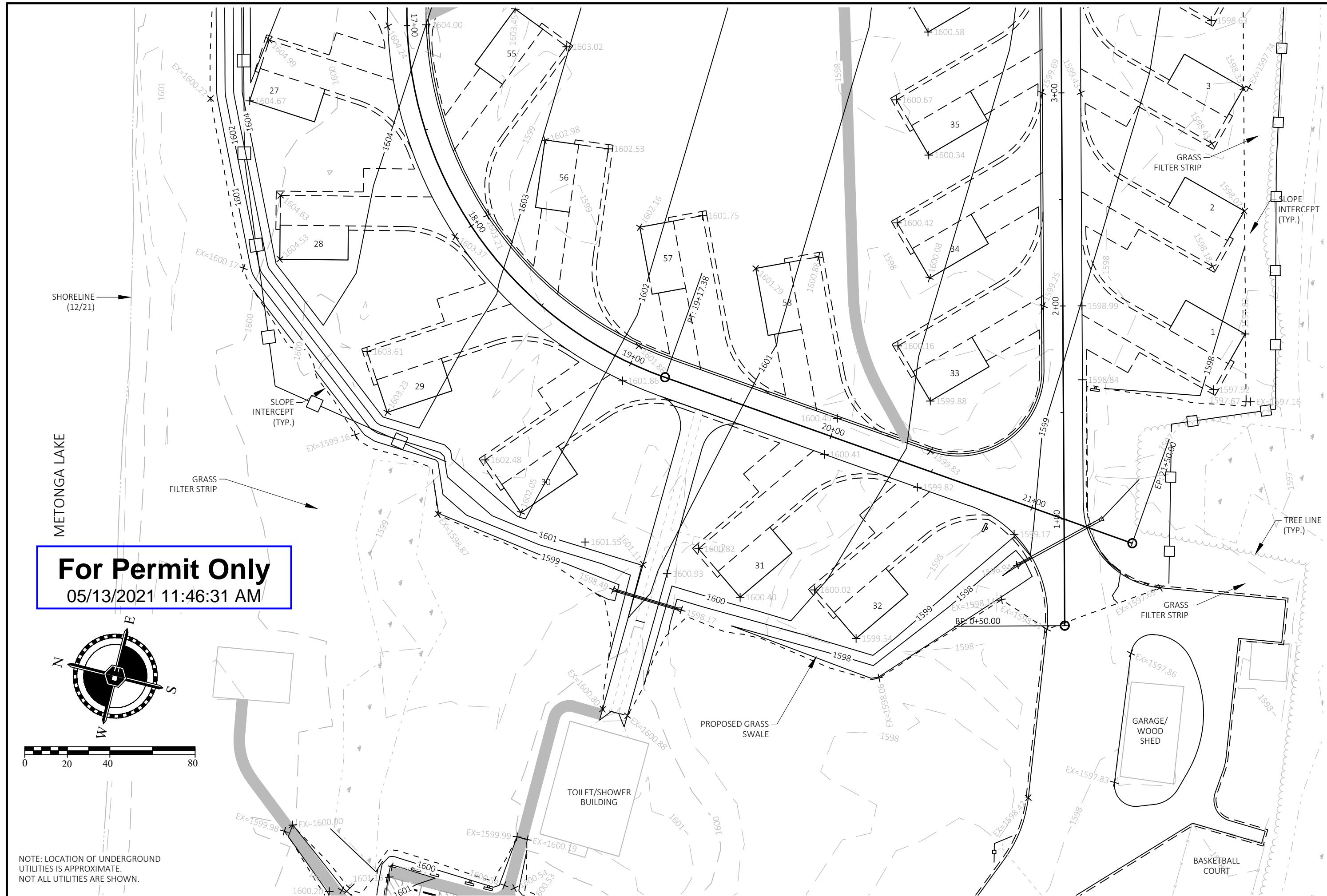

For Permit Only

05/13/2021 11:46:31 AM

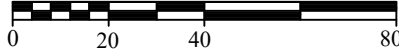
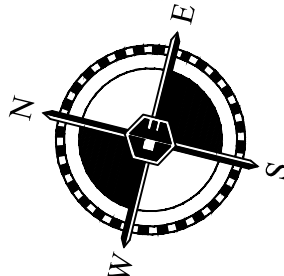

NOTE: LOCATION OF UNDERGROUND UTILITIES IS APPROXIMATE. NOT ALL UTILITIES ARE SHOWN.

SURVEYED BY:	CAD DRAWING:
CEC	200677-GRADING
DRAWN BY:	CHECKED BY:
SMF	XXX
DATE:	
5/13/21	

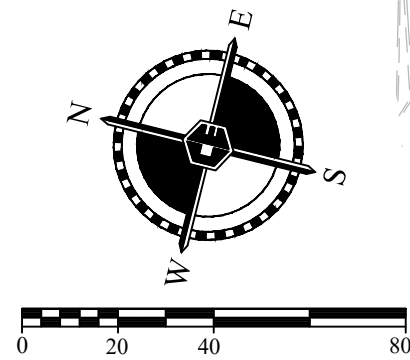

NOTE: LOCATION OF UNDERGROUND UTILITIES IS APPROXIMATE. NOT ALL UTILITIES ARE SHOWN.

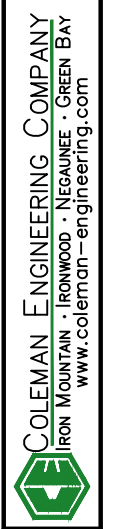

PROJECT: FOREST COUNTY VETERANS PARK RENOVATION PROJECT
SHEET NAME: PROPOSED GRADING OF MIDDLE OF RV PARK

PROJECT: FOREST COUNTY VETERANS PARK RENOVATION PROJECT

SURVEYED BY:	CEC
DRAWN BY:	SMF
CAD DRAWING:	200677-GRADING
CHECKED BY:	XXX
DATE:	5/13/21
CAD PROJECT:	200677

DRAWING NO. 24

For Permit Only
05/13/2021 11:46:31 AM

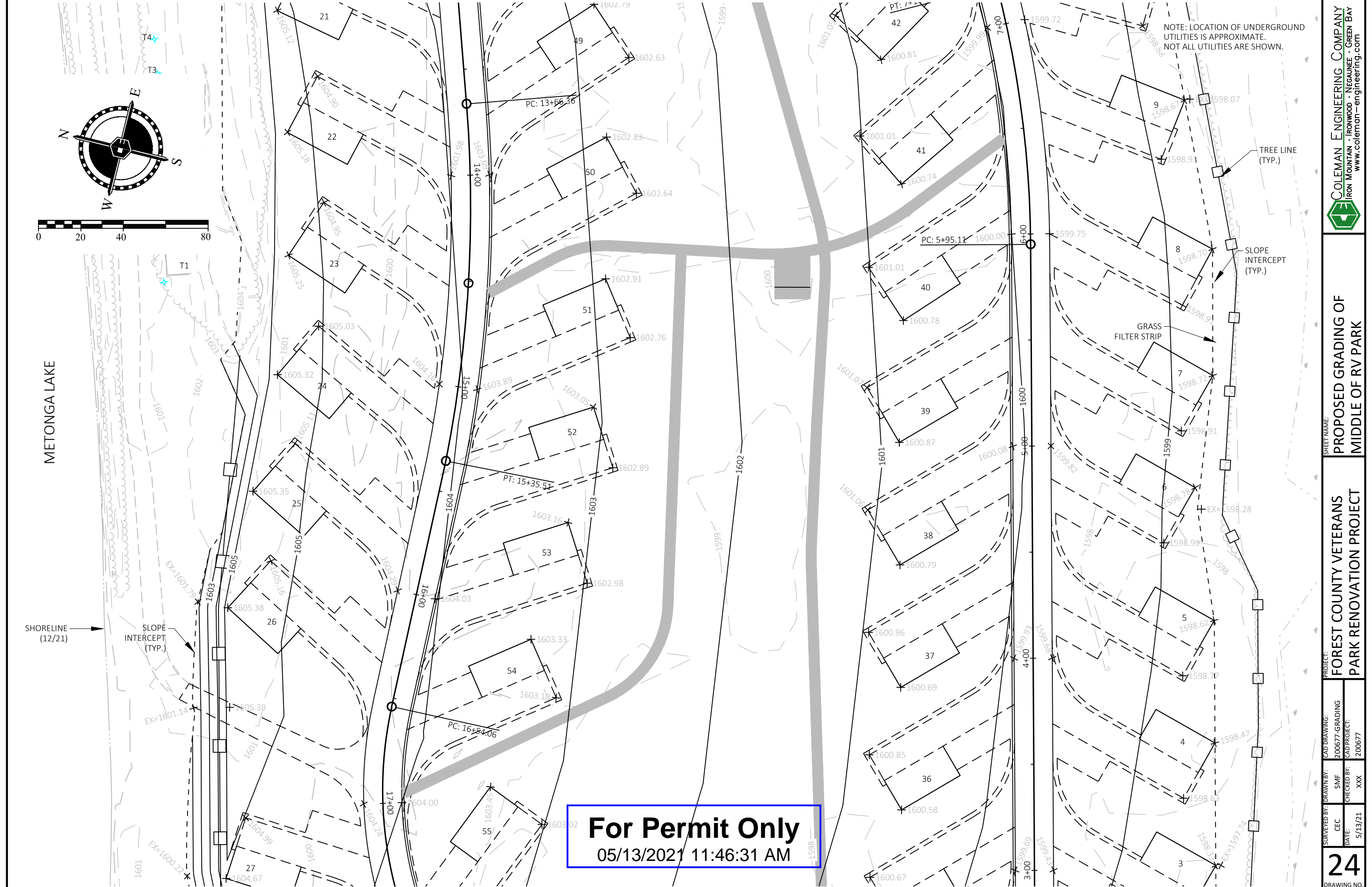

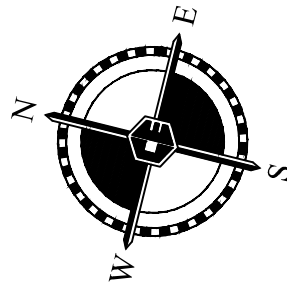

For Permit Only

05/13/2021 11:46:31 AM



NOTE: LOCATION OF UNDERGROUND UTILITIES IS APPROXIMATE. NOT ALL UTILITIES ARE SHOWN.

CHAIN LINK FENCE
(VERIFY LOCATION OF PROPERTY LINE)

NOTE: VERIFY TREE REMOVAL WITH OWNER

METONGA LAKE

SHORELINE
(12/21)

PARKING

SLOPE INTERCEPT
(TYP.)

SLOPE INTERCEPT
(TYP.)

GRASS FILTER STRIP

GRASS FILTER STRIP